

 TREASURE GARDEN

AKZ13 13'oc **Cantilever**

Assembly and Operation Guide

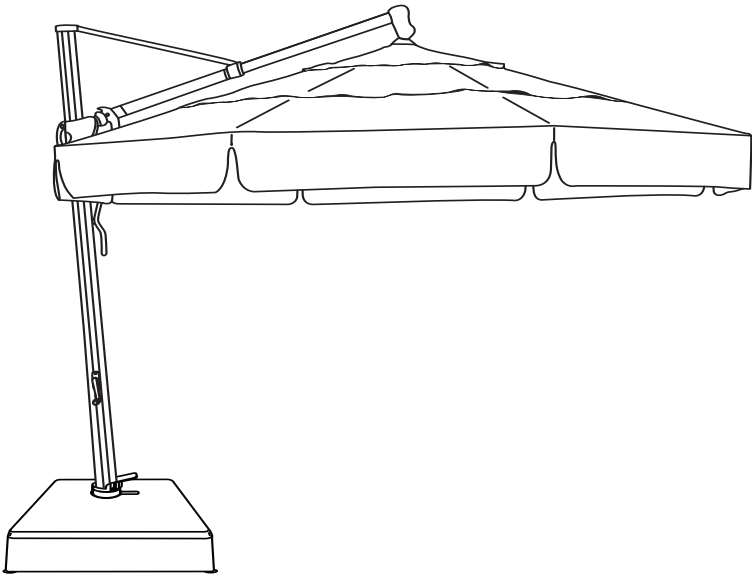

Thank you for your purchase of Treasure Garden's AKZ13 Cantilever Umbrella.

Please remove all contents from the package, inspect and review checklist.



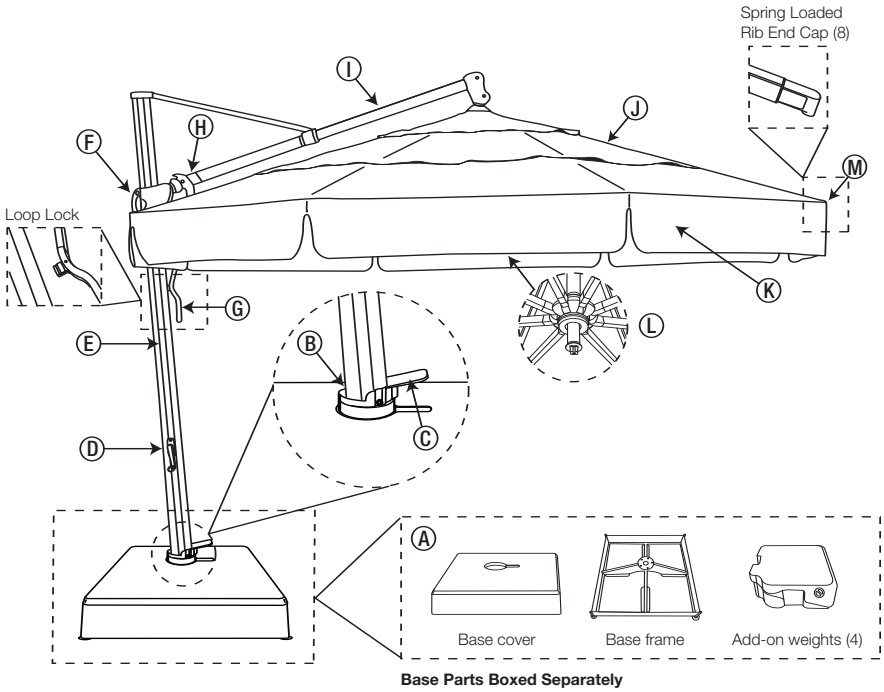









CAUTION: To reduce personal injury and damage to your AKZ13, read and follow this assembly and operation guide. We recommend a two-person team for assembly and disassembly. *Save information for future reference.*



AKZ13 CHECKLIST

- | | |
|--|---|
| A - Base Cover, Frame and Add-on Weights | H - Tilt Degree Scale |
| B - 360° Rotating Hub | I - Canopy Support Beam |
| C - Base Pedal | J - Canopy - Double Wind Vent |
| D - Crank Lift Handle | K - Valance (optional) |
| E - Main Frame Stand | L - Vega™ Light Adapter (light sold separately) |
| F - Main Frame Grip | M - Spring Loaded Rib End Cap |
| G - Tilt Lever | |

AKZ13 PART LIST

Part		Description	Qty.
①		Base Cover	1
②		Steel Base Frame	1
③		Add-On Weight Containers	4
④		Feet	4
⑤		Screws	4
⑥		Wrench	1
⑦		Bolts	5
⑧		Washers	5
⑨		Medium Hexagon Wrench	1
⑩		Playground Sand (not included)	400 lbs.
⑪		AKZ13 Main Frame	1
⑫		Large Hexagon Wrench	1
⑬		Crank Lift Handle	1
⑭		Small Hexagon Wrench	1

IMPORTANT: Prior to assembly it is important to decide on the location of the AKZ13 umbrella. The umbrella measures approximately 10 ft. in height and 13 ft. in width.

- Allow ample height to avoid damage to your umbrella during assembly and usage.
- Choose a location that is level and sturdy.
- Avoid any sloping or soft ground.
- Consider a location that will maximize the umbrella's rotating swivel function. Placing the AKZ13 between two entertaining areas is ideal.

NOTE: Some parts may be included in the styrofoam packaging. DO NOT discard any packaging or box until assembly is complete.

REQUIRED FOR ASSEMBLY:

- 400 lbs. playground sand (not included).

STEP 1 Base Assembly

Select area to set base frame and place in desired location. **NOTE:** Moving the umbrella will be difficult once fully assembled. Remove rotating hub from the main frame by removing the (2) bolts and (2) washers (Fig. 1), set aside bolts and washers for later use in step 2. Screw (4) feet onto bottom of base frame with supplied (4) screws (Fig. 2). Now, place rotating hub onto base frame and secure with supplied (5) bolts & (5) washers (Fig. 3). Remove caps from each add-on weight container and fill with dry playground sand (Fig. 4). The AKZ13 base containers hold up to 400 lbs. of sand. **IMPORTANT:** When filling the containers, it is necessary to wet down the sand after partial filling. After wet down, fill each add-on weight with remaining sand. Place each add-on weight container into base frame sections (Fig. 5). Carefully place base cover onto base frame (Fig. 6). **LEVELING:** If needed, adjust frame corners using supplied wrench until frame is level (Fig. 7).

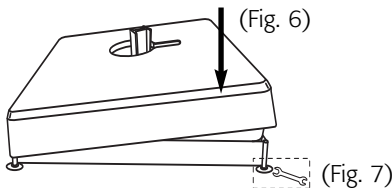
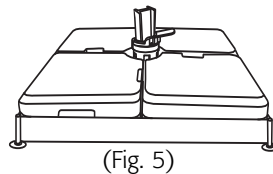
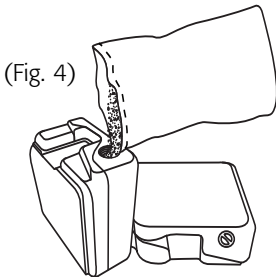
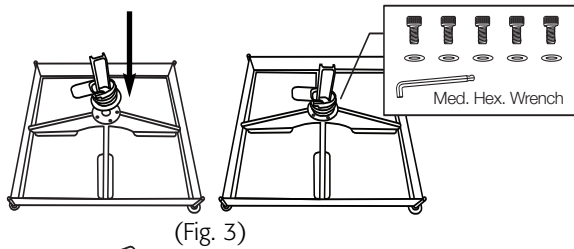
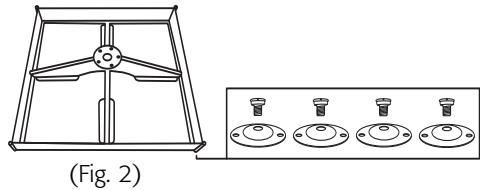
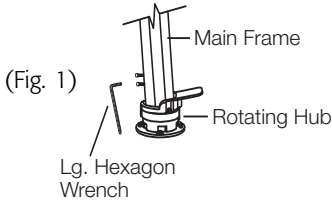

CAUTION: Fully assembled, the AKZ13 umbrella weighs over 500 lbs. Moving the umbrella fully assembled will increase the risk of damage to your umbrella and/or can cause serious injury. We recommend a two-person team for assembly and disassembly.

STEP 2 Umbrella Assembly

Two-persons recommended for team lift and to complete assembly.

With base cover in place, insert the main frame back onto the rotating hub (Fig. 8) {align tilt lever with foot pedal}. Assembled in upright position, re-insert the removed (2) bolts and (2) washers and tighten using large hexagon wrench provided (Fig. 9). Install the crank lift handle onto the mid-area of the main frame. Use the small hexagon wrench provided to lock in the small screw (Fig. 10).

REMOVE ALL PLASTIC PACKAGING MATERIAL FROM ALL PARTS PRIOR TO OPENING UMBRELLA. CHECK UNDER CANOPY FOR PACKAGING AROUND RIBS.

Your AKZ13 umbrella is now ready to operate!

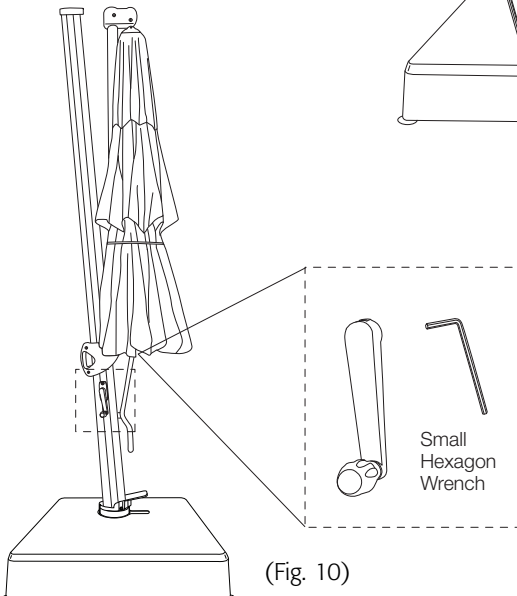
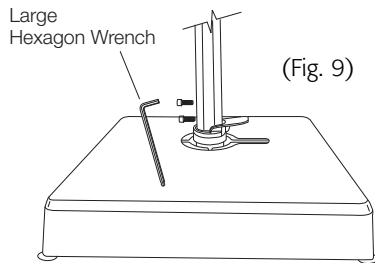
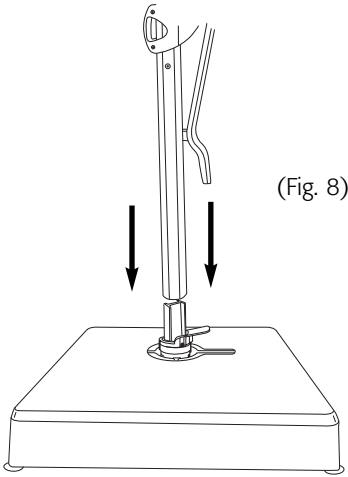

STEP 3 Operation

To Open Canopy:

Slowly turn the crank lift handle clockwise  to open the umbrella to a level position (Fig. 11). **CAUTION:** Stop turning the crank handle as soon as the umbrella cover is completely open and the sleeve on the umbrella pole has reached its maximum height (Fig. 12).

WARNING: Do not continue to crank once umbrella canopy is completely open, it may impair your ability to disengage the tilt lever.

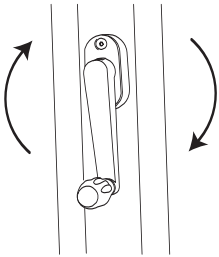

(Fig. 11)

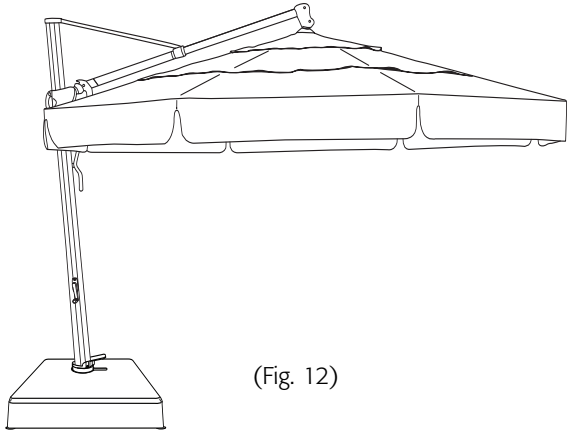

(Fig. 12)

To Close Canopy:

Slowly turn the crank lift handle counter-clockwise  (Fig. 13) with one hand and slide the main frame grip down with the other hand (Fig. 14) until the canopy is fully closed (Fig. 15). **NOTE:** Prior to closing insure that the canopy is in a level (non-tilted) position.

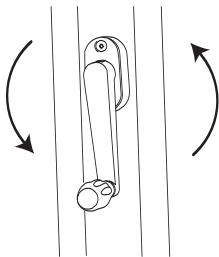

(Fig. 13)

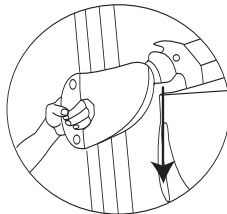

(Fig. 14)

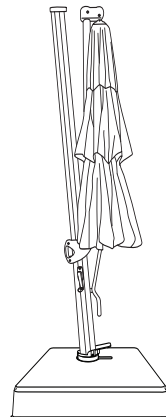

(Fig. 15)

IMPORTANT: PRIOR TO USING THE TILT FEATURE. To avoid personal injury or damage to the AKZ13 umbrella, make sure the area behind you is clear and free from any furniture or structure.

To Tilt Canopy:

Make sure canopy is fully OPEN. Position yourself in front of the tilt lever and pull loop lock from main frame track (Fig. 16). Pull out further to dis-engage tilting gears and reveal gear teeth (Fig. 17). Move the tilt lever to the left or right, opposite the desired tilt direction (Fig. 18). Use the tilt degree scale as a guide (Fig. 19). Now, push forward slightly to re-engage tilting gear teeth. Move tilt lever to center position (canopy should be moving also) and snap the loop lock back into main frame track.

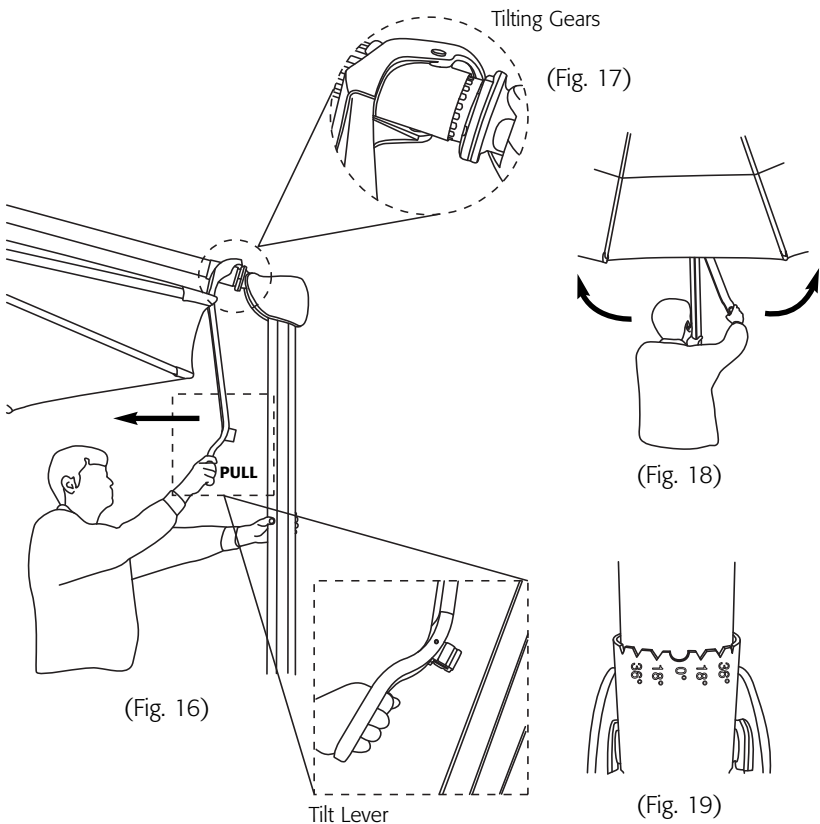

To OPERATE the 360° Rotating Hub Swivel:

Place your foot on the foot pedal of the rotating hub and *step-on* the base pedal to release rotating lock (Fig. 20). Place one hand on the main frame and one hand on the tilt lever (Fig. 21), swivel the umbrella frame in either direction until desired position is reached (Fig. 22). Step off the foot pedal to engage rotating lock and lock position (you will hear the pedal click, as it reaches the next available lock position).

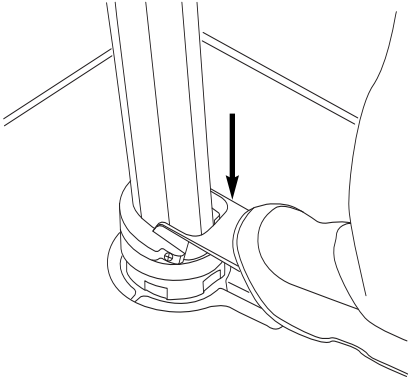

(Fig. 20)

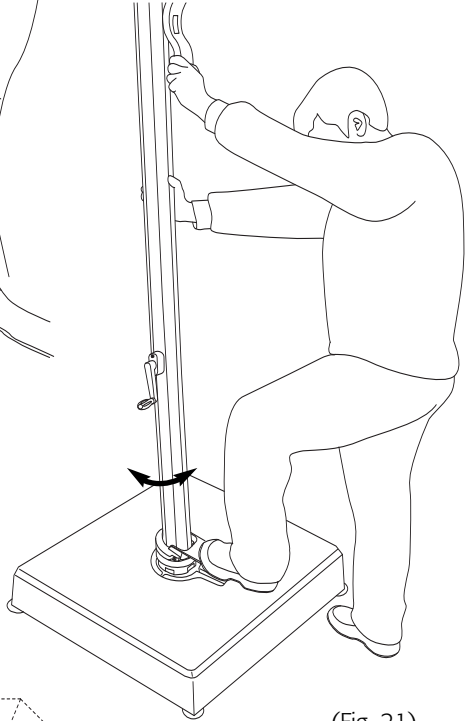

(Fig. 21)

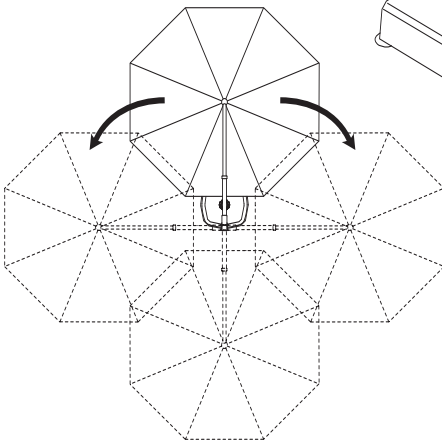

(Fig. 22)

To ATTACH VEGA Umbrella Light: (sold separately)

Loosen the VEGA light adapter built into the umbrella runner by turning counter-clockwise  (Fig. 23). After loosening, pull down light adapter post (Fig. 24) to attach the VEGA umbrella light (sold separately).

To OPEN and ATTACH VEGA:

Open the VEGA umbrella light by holding firmly with one hand and then depress the clamp release button with the other hand to release the clamp lock. Open up the VEGA light and clasp around the light adapter post (Fig. 25). Snap to close (Fig. 26).

To REMOVE VEGA and CLOSE adapter:

Hold the VEGA umbrella light, depress the clamp release button to release the clamp lock. Remove VEGA umbrella light, and gently push up the light adapter post back into umbrella runner and tighten turning clockwise  **NOTE:** It is not necessary to remove light to close umbrella.

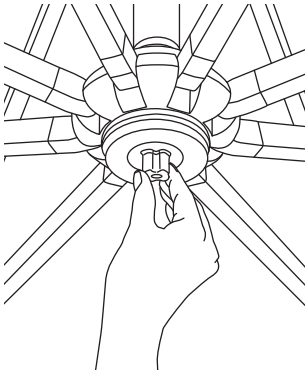

(Fig. 23)

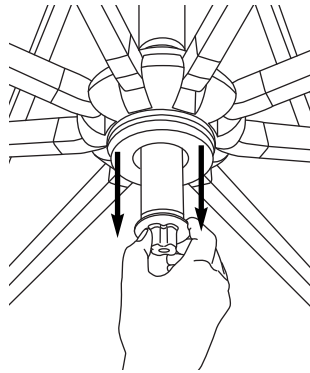

(Fig. 24)

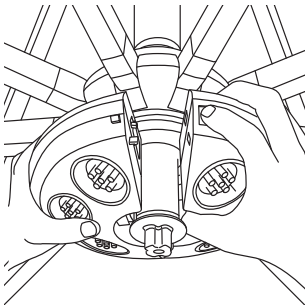

(Fig. 25)

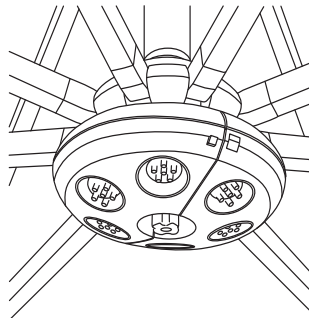

(Fig. 26)

S A F E T Y P R E C A U T I O N S :

- Close the umbrella in windy conditions or when a storm approaches. Never allow the umbrella to flap in the wind; this could damage the canopy.
- Do not leave open umbrella unattended. If damage occurs, this is not covered by the warranty.
- When adjusting the umbrella, make sure that no person(s) or item(s) are close to the umbrella. This is important to prevent injury or material damage.

C A R E A N D M A I N T E N A N C E :

- When not in use, close and cover umbrella with a protective cover.
- If necessary, clean the fabric with lukewarm water, mild detergent, and a sponge.
- Allow a wet canopy to dry slightly opened, but do not leave unattended.
- Wipe sliding marks on the aluminum poles with a damp cloth.

Winter Storage:

- Store in a dry place.
- Any visible defects must be repaired by a professional.

After the Winter:

- Areas subject to turning and sliding can be treated with a non-staining lubricant spray (silicone-based).
- Check the condition and function of the umbrella. Any defects must be repaired by a professional.

CAUTION: Fully assembled, the AKZ13 umbrella weighs *over 500 lbs.*

Moving the umbrella fully assembled will increase the risk of damage to your umbrella and/or can cause serious injury. *We recommend a two-person team for assembly and disassembly.*

WARRANTY:

Treasure Garden warrants this product (in residential use) to be free from defects in original materials and workmanship for a period of 2 year from the date of purchase. If a defect in the original material or workmanship appears during the warranty period; Treasure Garden will (at its option) repair or replace the product without charge.

Simply contact your original authorized Treasure Garden dealer with a description of the defect. The dealer will verify the defect and work closely with Treasure Garden to obtain the necessary service. In many cases, simple problems can be solved with a replacement part that can be shipped directly to the dealer for professional installation / repair.

In the event that warranted factory service is required, Treasure Garden will assume the responsibility of the return

freight charges on warranted product for the first year only.

Returned product that (upon receipt and inspection) is deemed to be "not covered" under our warranty, will be shipped / billed at your expense.

This warranty gives you specific legal rights, and you may have other rights which vary from state to state.

RUST: Rust is a natural part of the aging process of steel or iron based materials, and is therefore NOT considered a defect.

NOTE: Failure caused by unreasonable or abusive use, or failure caused by neglect of reasonable and necessary care are not covered by this warranty.

Additionally, acts of nature (including but not limited to wind, hurricanes, tornadoes, and storms) are not covered by this warranty.



www.treasuregarden.com

©2012 Treasure Garden, Inc. - All Rights Reserved.

Rev. 10/12