

BW30
30_{LB}
**Add-On
Weight**

Assembly and Operation Guide

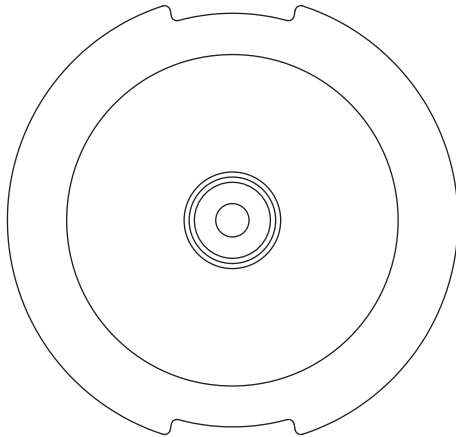

Thank you for your purchase of Treasure Garden's BW30 Add-on Weight.

Please remove all contents from the package, inspect and review checklist.

BW30 CHECKLIST

A - Add-on Weight

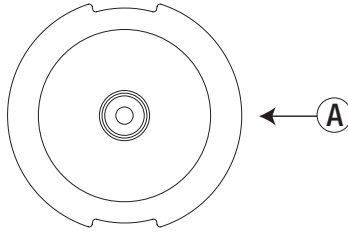

Step 1

Tilt base back to its side (Fig. 1). Attach add-on weight by inserting the add-on weight into the center threads of the base (Fig. 2) and turn clockwise  (Fig. 3) until fully tightened (Fig. 4). Turn base upright. Your base is ready for use.

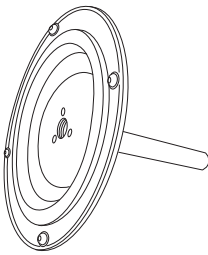

(Fig. 1)

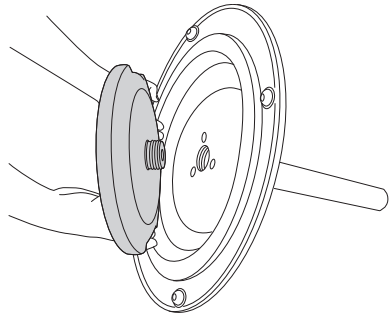

(Fig. 2)

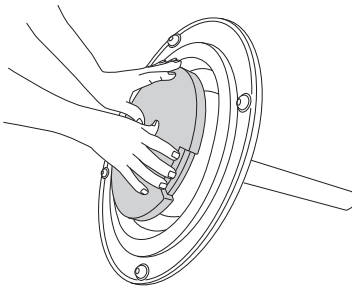

(Fig. 3)

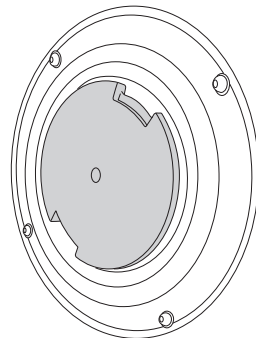

(Fig. 4)

Dimensions

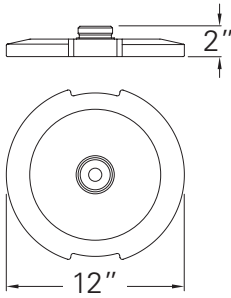

WARRANTY:

Treasure Garden warrants this product (in residential use) to be free from defects in original materials and workmanship for a period of 1 year from the date of purchase. If a defect in the original material or workmanship appears during the warranty period; Treasure Garden will (at its option) repair or replace the product without charge.

Simply contact your original authorized Treasure Garden dealer with a description of the defect. The dealer will verify the defect and work closely with Treasure Garden to obtain the necessary service. In many cases, simple problems can be solved with a replacement part that can be shipped directly to the dealer for professional installation / repair.

In the event that warranted factory service is required, Treasure Garden will

assume the responsibility of the return freight charges on warranted product for the first year only.

Returned product that (upon receipt and inspection) is deemed to be "not covered" under our warranty, will be shipped / billed at your expense.

This warranty gives you specific legal rights, and you may have other rights which vary from state to state.

RUST: Rust is a natural part of the aging process of steel or iron based materials, and is therefore NOT considered a defect.

NOTE: Failure caused by unreasonable or abusive use, or failure caused by neglect of reasonable and necessary care are not covered by this warranty.

Additionally, acts of nature (including but not limited to wind, hurricanes, tornadoes, and storms) are not covered by this warranty.

CAUTION: HANDLE WITH CARE

- To reduce personal injury and damage, read and follow this Assembly and Operation information.
- Close the umbrella in windy conditions or when a storm approaches. Never allow the umbrella to flap in the wind; this could damage the canopy.
- Do not leave open umbrella unattended.
- Do not allow children to play on or with the base.



www.treasuregarden.com

©2012 Treasure Garden, Inc. - All Rights Reserved.

Initial 12/12